

Industrial remote control
F24 series

F24-6S/ F24-6D



F24-8S/ F24-8D



F24-10S/ F24-10D



F24-12S/ F24-12D



- Durable nylon-fiber housing for extra shock resistance..
- Low power consumption with 2 AA batteries (last up to 2 months in normal operation)
 - Operating range up to 100 meters
 - Programmable function setting through Windows-based software.
 - Economic efficiency, ease of operation.
 - Pre-wiring standard cable making wiring procedures easier.
 - 100% compatible components reducing stock of spare part.

- Safety features:
- ☆ 4.3 billion unique ID code
 - ☆ Hamming code
 - ☆ enhanced watch-dog circuit

General Specification	
Operating Temp.	-35°C ~ +80°C
Maximum Range	100 M
TX power supply	2 AA size Alkaline batteries
RX power supply	AC 24/48/110/220/380 V DC 24 V
Protection class	IP 65 Industrial standard
ID Code	4.3 billion (32 bit)
Hamming code distance	≥ 4
TX Dimension & Weight	186 x 61 x 51 mm Apprx. 255g (w/o batteries)
RX Dimension & Weight	200x162x107mm Apprx.1220g (w/o cable)
Operating frequency	433.05~434.79
Transmitting power	Less than 10mW

Industrial remote control - TELECRANE of Taiwan
F21 series

F21-2S/ F21-2D



F21-4S/ F21-4D



F21-E1



F21-E1B



- Features
- 2~6 commands (Pocket size transmitter : F21-2S/D)
 - Low cost for electronic chain hoist/monorail
 - Low power consumption transmitter. 2 AA batteries last up to 4 months
 - Extra shock resistant relay specially for mobile devices (DC model only)
 - Over 4.3 billions unique ID code available.
 - Temperature range -35°C ~ +85°C
 - Enclosure protection class IP 65
 - Microsoft Windows based software for easy customize configuration
 - Structure : Glass-Fiber

- Transmitter
Dimension:
- 130 x 45 x 22 mm (F21-2S/D model)
 - 156 x 61 x 51 mm (F21-4S/D model)
 - 164 x 75 x 46 mm (F21-4SB model)
 - 156 x 61 x 51 mm (F21-E1 model)
 - 164 x 75 x 46 mm (F21-E1B model)
- Receiver
- Dimension: 185x85x85mm
 - Weight: 550g (w/o wire cable)
 - Receiver Power Supply: 24/48/110/220/380 VAC & 12/24V DC
- Weight :
- Approx. 120~380g (without batteries)

Remote control
F24-60 Double Joystick



Operating Temp.	-35°C ~ +80°C
Maximum Range	100 M
TX power supply	4 AA size Alkaline batteries
RX power supply	24/48/110/220/380 V
ID Code	IP 65 Industrial standard
Hamming code distance	4.3 billion (32 bit)
TX Dimension & Weight	> 4
RX Dimension & Weight	220x110x90 mm Apprx. 860g (w/o batteries)
	290x230x70mm Apprx.2200g (w/o cable)

Remote control
F21 New Technical Series

F21-E2S



F21-E2B



F21-E2M



F21-E2B-8



F21-E2M-8



General Specification	
Operating Temp.	-30°C ~ +85°C
Maximum Range	20M ~ 100 M
TX power supply	2 AA size Alkaline batteries
RX power supply	24 / 36 / 48/ 110/ 220/ 380VAC± 20% (single option)
ID Code	4.3 billion (32bit an unique non-repeated)

Model	Transmitter		Receiver	
	Dimension (mm)	Weight (g)	Dimension (mm)	Weight (g)
F21-E2S	135 x 55 x 40	155g	200x 85 x 60	785g
F21-E2B	165 x 75 x 45	295g		
F21-E2M	165 x 50 x 50	200g		
F21-E2B-8	165 x 75 x 45	305g		
F21-E2M-8	165 x 50 x 50	210g		

* weight with batteries

Features

- ☆ Auto Frequency Selection
 - Chooses top grade RF IC with sophisticated design, it provides great performance on radio channel selectivity
 - No channel changing required when multiple radio controller are used at the same time
- ☆ Radio Frequency Filtering
 - A sophisticated surface acoustic wave(SAW) filter blocks unwanted radio signal to ensure smooth radio link
- ☆ E-card (plug and play)
 - E-card works similar to SIM card in the mobil phone
 - All system data are carried on a small e-card for easy transfer to a spare system when needed
 - E-card is interchangeable between transmitter and receiver. it allows spare transmitter or receiver to resume to work without any downtime.
- ☆ E-card Duplicator
- ☆ Reliable Communication
- ☆ Budget & Environmental Saving
- ☆ Security Enhanced & Anti-Spy
- ☆ Heavy Duty

Remote control Accessoires



USB Cable



Copier



EMS Button



Switch



TX Main Board



K Board



RX Board

Industrial remote control
F24+ series

F24-6S+/ F24-6D+ F24-8S+/ F24-8D+ F24-10S+/ F24-10D+ F24-12S/ F24-12D+

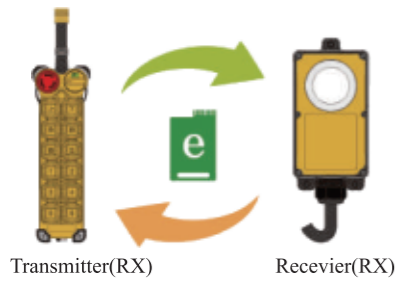

Transmitter(RX) Receiver(RX)

Security Enhanced & Anti-Spy
Budget & Environmentally Friendly
Powerful Customized Software

e-Card(plug and play)
Enhanced Durability
Take & Release
(Receiver with multi-users)

General Specification

Operating Temp.	-30°C ~ +85°C
Maximum Range	Adjustable
TX power supply	4 AA size Alkaline batteries
RX power supply	AC 24/36/48/110/220/380 V DC 24 V
Protection class	IP 65 Industrial standard
ID Code	4.3 billion (32 bit)
Hamming code distance	≥ 20
TX Dimension & Weight	245 x 61 x 51 mm Apprx. 255g (w/o batteries)
RX Dimension & Weight	234x116x130mm Apprx.1240g (w/o cable)
Operating frequency	433.05~434.79

Industrial remote control - TELECRANE of Taiwan
F24-60+ Double Joystick

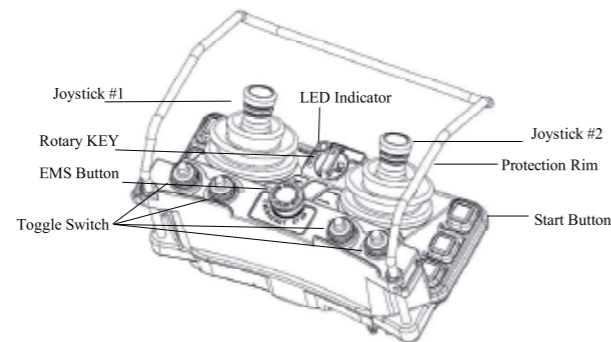

Operating Temp.	-35°C ~ +80°C
Maximum Range	150 M
TX power supply	4 AA size Alkaline batteries
RX power supply	24/48/110/220/380 V
ID Code	IP 65 Industrial standard
Hamming code distance	4.3 billion (32 bit)
TX Dimension & Weight	> 4
RX Dimension & Weight	220x110x90 mm Apprx. 860g (w/o batteries) 290x230x70mm Apprx.2200g (w/o cable)

Pendant control - Double Step Button Control
NXAC Series



NXAC series,

1. Two speed control buttons,
2. IP65
3. New ABS material,
4. conductiv copper-based electrical contact
5. silver-nickel alloy contact surface
6. Applicable to dust, outdoor, rain and son operating environment.

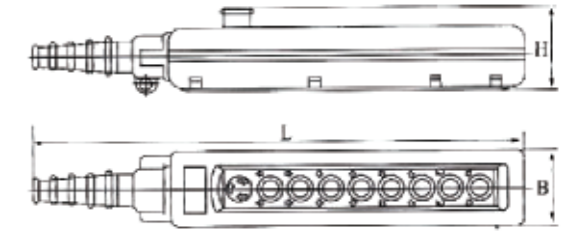

Type	Buttons	L x B x H
NXAC-03	3	310 x 78 x 85
NXAC-05	5	370 x 78 x 85
NXAC-07	7	430 x 78 x 85
NXAC-09	9	490 x 78 x 85
NXAC-11	11	550 x 78 x 85

Code

A-
Power control switch



B-
Start--stop button



C-
Double speed button



P-
On-off NO type button



Electric Diagram

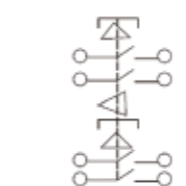
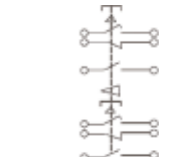
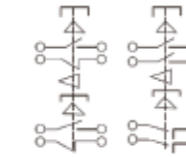
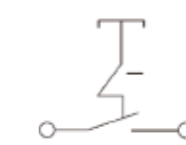

Feature

self-lock, connect or separate whirling 30°, auto reset

Two buttons inter-lock, auto reset, normal-off separates first and normal-on connects

Two buttons interlock, auto reset pressed to the first floor Normal-off separates and Normal-on connects. Pressed to end later Normal-on connects

Two buttons interlock, auto rest, it is the most popular buttons.